



**WELCOME TO SUMMERAMA**

July 1-4, 2010

**CELEBRATING OUR 25th YEAR!**

# **SUMMERAMA 2010**

## **AREA 3 QUARTER HORSE PROMOTIONAL CLUB**

### ***Welcomes their Judges for the 25<sup>th</sup> Anniversary of Summerama***

#### **MARTY JO HAYS**

With her parents married on horseback, Marty Jo was destined to be involved in the horse business. She started showing AQHA as a youth, with a judging career soon to follow. Her judging resume is lengthy, carrying judge's cards in AQHA, APHA and NSBA, judging approximately 20 shows per year. Ms. Marty Jo Hays judged the 2007 APHA World Show. Marty Jo has judged numerous shows and futurities including 148 Paint Horse Shows since earning her APHA Judge's card in 1980.

As a riding instructor and trainer, she specializes in novice showman and beginner riders at her home near Eaton, Ohio.

Marty Jo and her husband, Gary will soon be celebrating their 33<sup>rd</sup> Wedding Anniversary.

#### **JOHN TUCKEY**

John Tuckey is a judge for AQHA, NCHA, NRHA, NRCHA AND NSBA. He has judged many major events over the years, including the AQHYA World Show, the AQHA Select World Show, the All American Quarter Horse Congress, Arizona Sun Circuit, Florida Gold Coast, the Reichert Pleasure Celebration, the Texas Classic, the NRHA Derby and Futurity, the NSBA Championship Show, Quarterama, and most the major Futurity shows and Stock Shows. He has also judged the European Championship and the Americana.

John and his wife, Betsy own and operate JBT Quarter Horses, where they raise and train their own horses. He is a member of the KyQHA and the Professional Horseman's Committee.

John and Betsy have one son, Trevor. They reside in Kentucky.

#### **DEBBIE CUVELIER**

A native of Dixon, Illinois, Debbie brings to you over 35 years of involvement with AQHA. She began showing in Youth Activity, trained horses and riders for many years, then became an AQHA Judge in 1997. Since then, she has judged over 200 Quarter Horse Shows across the USA, every province in Canada, along with Germany and Japan. Debbie also holds her PHBA and NSBA Judge's Cards. Among the major shows she has judged are the Gold Coast, Gulf Coast, Red Bud, East Coast Championship, PHBA World Show (2 times), NSBA Breeders' Championship and the Maha Cup in Japan.

In 2004, she coached Team USA to victory in at AQHA's Youth World Cup competition in Dubbo, Australia.

Debbie and her husband, Scott, operate their family owned, cattle auction barn, Walnut Auction Sales. Any free time is spent on the golf course.

**CLAY MacLEOD**

Mr. Clay MacLeod has been an AQHA approved judge for 23 years. He also holds his NSBA Judge's Card. Mr. MacLeod has judged the AQHA World Show, 5 times; the AQHA Youth World and the Select Amateur World Show and the European Championships, 2 times as well as the Australian Championships. He has judged the Congress 5 times as well as judging in England, Italy & Australia.

Clay is an AQHA Director and he has been an AQHA Affiliate Council Member for 3 Years. Mr. MacLeod is a Past President of the Pacific Coast Quarter Horse Association & The Pacific Southwest Quarter Horse Association. He has shown 2 World Champions and coached or trained Youth & Amateurs to World Championships.

Clay has been married to his wife, Elizabeth for 14 years. They own and operate Highland Farms Quarter Horses in Rancho Santa Fe, California.



**MARTY JO HAYS**

**JOHN TUCKEY**

**DEBBIE CUVELIER**

**CLAY MacLEOD**

**SUMMERAMA 2010, 25<sup>th</sup> Anniversary**  
**Thursday, July 1, 2010**

**Judges: MARTY JO HAYS, Oh**  
**JOHN TUCKEY, Ky**

1. Walk A to B.
2. Stop at B. Turn 270 degrees.
3. Trot around C and D.
- Stop and set-up for inspection.
4. Back 5 steps. Turn 90 degrees.
5. Trot to exit.

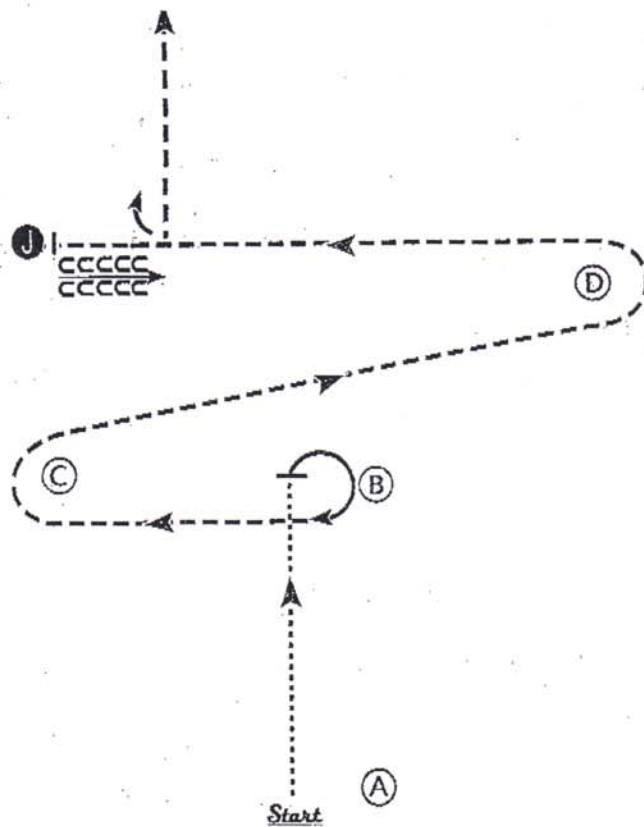

*Pattern Legend*

Walk	.....
Jog/Trot	-----
Lope/Canter	—————
Extended Trot/Jog	———
Leg Yield	
Hand Gallop	-----
Change Lead	≠
Gate	< >
Back	← < > ←
Judge	ⓐ
Marker	ⓐ
Sidepass	←←

**SUMMERAMA 2010, 25<sup>th</sup> Anniversary**  
 Thursday, July 1, 2010

**Judges: JOHN TUCKEY, Ky**  
**MARTY JO HAYS, Oh**

1. Walk A to B.
2. Stop at B. Turn 270 degrees.
3. Trot around C and D to E. Stop at E.
4. Back. Turn 90 degrees.
5. Walk to the judge and set-up for inspection.
6. Trot to exit when dismissed from inspection.

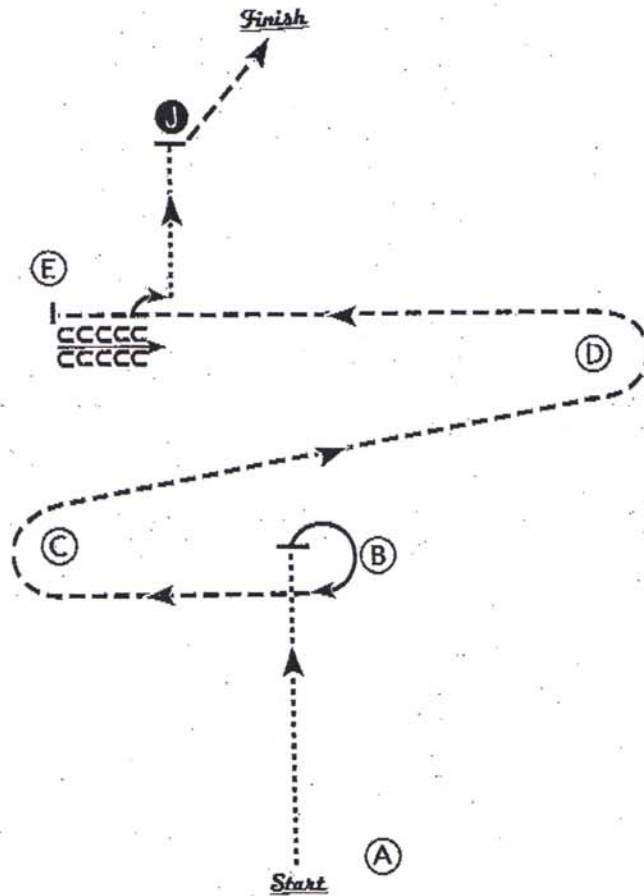

**Pattern Legend**

- Walk ..... (dotted line)
- Jog/Trot - - - - - (dashed line)
- Lope/Canter ——— (solid line)
- Extended Trot/Jog - - - - - (long-dashed line)
- Leg Yield ||||| (vertical bars)
- Hand Gallop ——— (line with diagonal dashes)
- Change Lead ↯ (diagonal slash)
- Gate ||| (vertical bars with a peak)
- Back ←←← (line with arrows pointing left)
- Judge ● (solid circle)
- Marker ○ (open circle)
- Sidepass ←←← (line with arrows pointing left)

# SMALL FRY Showmanship

SUMMERAMA 2010, 25<sup>th</sup> Anniversary  
Thursday, July 1, 2010

Judges: MARTY JO HAYS, Oh  
JOHN TUCKEY, Ky

1. Walk A to B.
2. Stop at B. Turn 270 degrees.
3. Trot around C and D to the judge and set-up for inspection. exit when dismissed

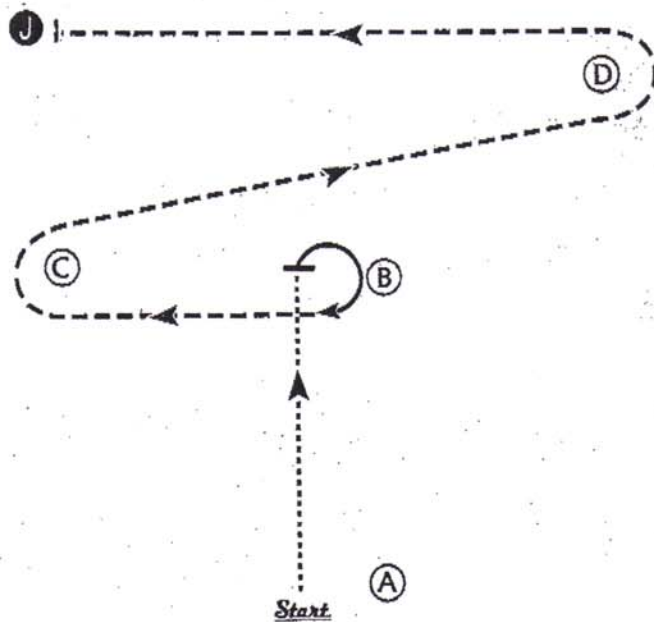

## Pattern Legend

- Walk ..... (dotted line)
- Jog/Trot - - - - - (dashed line)
- Lope/Canter \_\_\_\_\_ (solid line)
- Extended Trot/Jog \_\_\_\_\_ (long-dashed line)
- Leg Yield ||||| (vertical bars)
- Hand Gallop \_\_\_\_\_ (line with diagonal dashes)
- Change Lead ≠ (not-equal symbol)
- Gate ||| (three vertical bars)
- Back ←←← (three arrows pointing left)
- Judge ● (solid circle)
- Marker ○ (open circle)
- Sidepass ←← (two arrows pointing left)

# Hunt Seat Equitation

Novice Amateur and Youth

**SUMMERAMA 2010, 25<sup>th</sup> Anniversary**  
Thursday, July 1, 2010

**Judges: JOHN TUCKEY, Ky**  
**MARTY JO HAYS, Oh**

1. Begin at A. Walk halfway to B. Sitting trot to B.
2. Canter in the left lead around B.
3. Halfway to C, drop to the posting trot on the left diagonal.
4. After rounding C, canter on the right lead to D.
5. Stop at D. Back

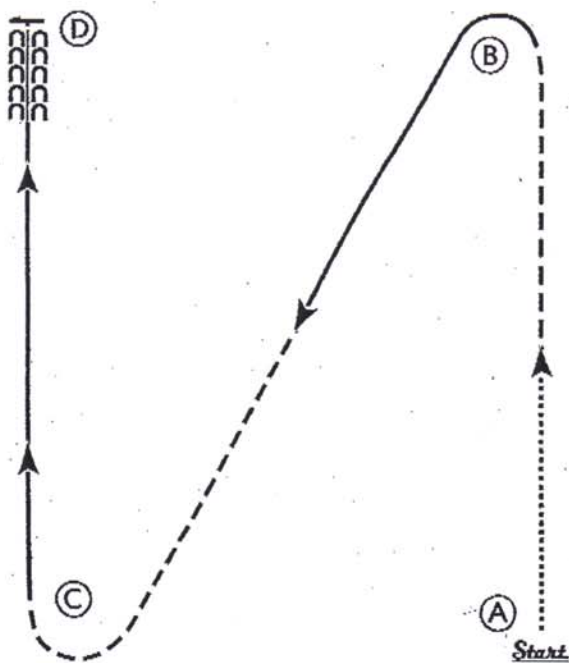

## Pattern Legend

- Walk ..... (dotted line)
- Jog/Trot - - - - (dashed line)
- Lope/Canter \_\_\_\_\_ (solid line)
- Extended Trot/Jog - - - - (long dashed line)
- Leg Yield | | | | | (vertical bars)
- Hand Gallop - - - - (dash-dot line)
- Change Lead ≠ (not equal symbol)
- Gate II II (gate symbol)
- Back ← ← ← (back symbol)
- Judge J (circle with J)
- Marker O (circle)
- Sidepass ← ← ← (sidepass symbol)

# Hunt Seat Equitation

Amateur **SELECT** Youth 13 & Under Youth 14-18

**SUMMERAMA 2010, 25<sup>th</sup> Anniversary**

Thursday, July 1, 2010

Judges: **MARTY JO HAYS, Oh**  
**JOHN TUCKEY, Ky**

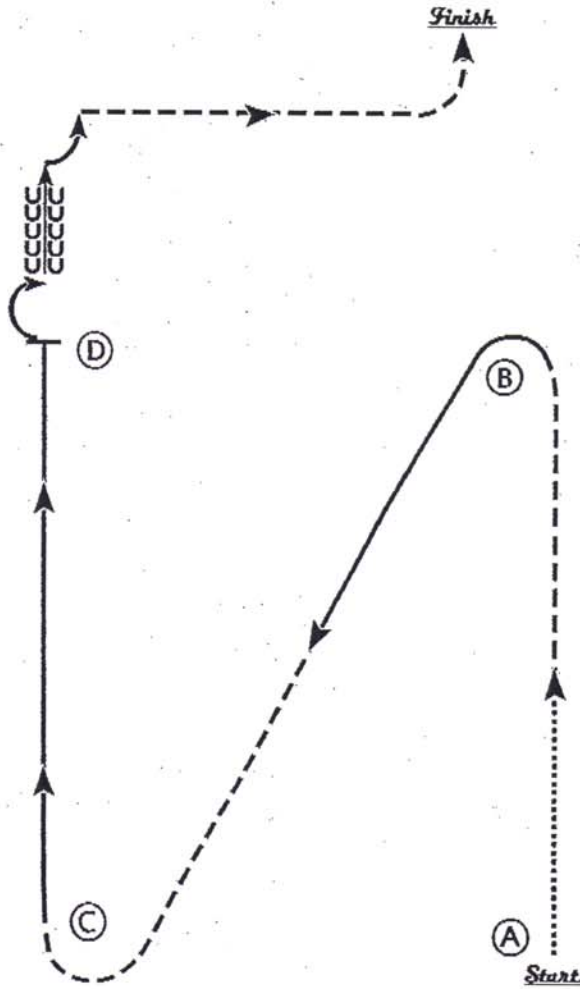

1. Begin at A. Walk halfway to B. Sitting trot to B.
2. Canter in the left lead around B.
3. Halfway to C, drop to the posting trot on the left diagonal.
4. After rounding C, canter on the right lead to D.
5. Stop at D. Turn 180 degrees on the forehand to the right. Back 5 steps.
6. Turn 90 degrees on the forehand to the left. Sitting trot to exit.

## Pattern Legend

Walk	.....
Jog/Trot	- - - - -
Lope/Canter	—————
Extended Trot/Jog	———
Leg Yield	
Hand Gallop	.....
Change Lead	≠
Gate	>
Back	← 33
Judge	●
Marker	○
Sidepass	←←←

# SUMMERAMA 2010, 25<sup>th</sup> Anniversary



**REINING PATTERNS FOR Thursday, July 1:**

**YOUTH REINING #8  
OPEN REINING #8  
AMATEUR REINING #5**

**WESTERN RIDING PATTERNS for Friday, July 2:**

**(Green Western Riding Pattern #3)  
ALL OTHER WESTERN RIDING CLASSES #4**

***Judges:* JOHN TUCKEY, Ky  
MARTY JO HAYS, Oh**



**REINING PATTERNS FOR SUNDAY, JULY 4:**

**YOUTH REINING #2  
OPEN REINING #10  
AMATEUR REINING #2**

**WESTERN RIDING PATTERNS for SATURDAY, JULY 3:**

**(Green Western Riding Pattern #2)  
ALL OTHER WESTERN RIDING CLASSES #2**

***Judges:* CLAY MACLEOD, Ca  
DEBBIE CUVELIER.**

FRIDAY JULY 2

# Green, Jr., Youth Trail

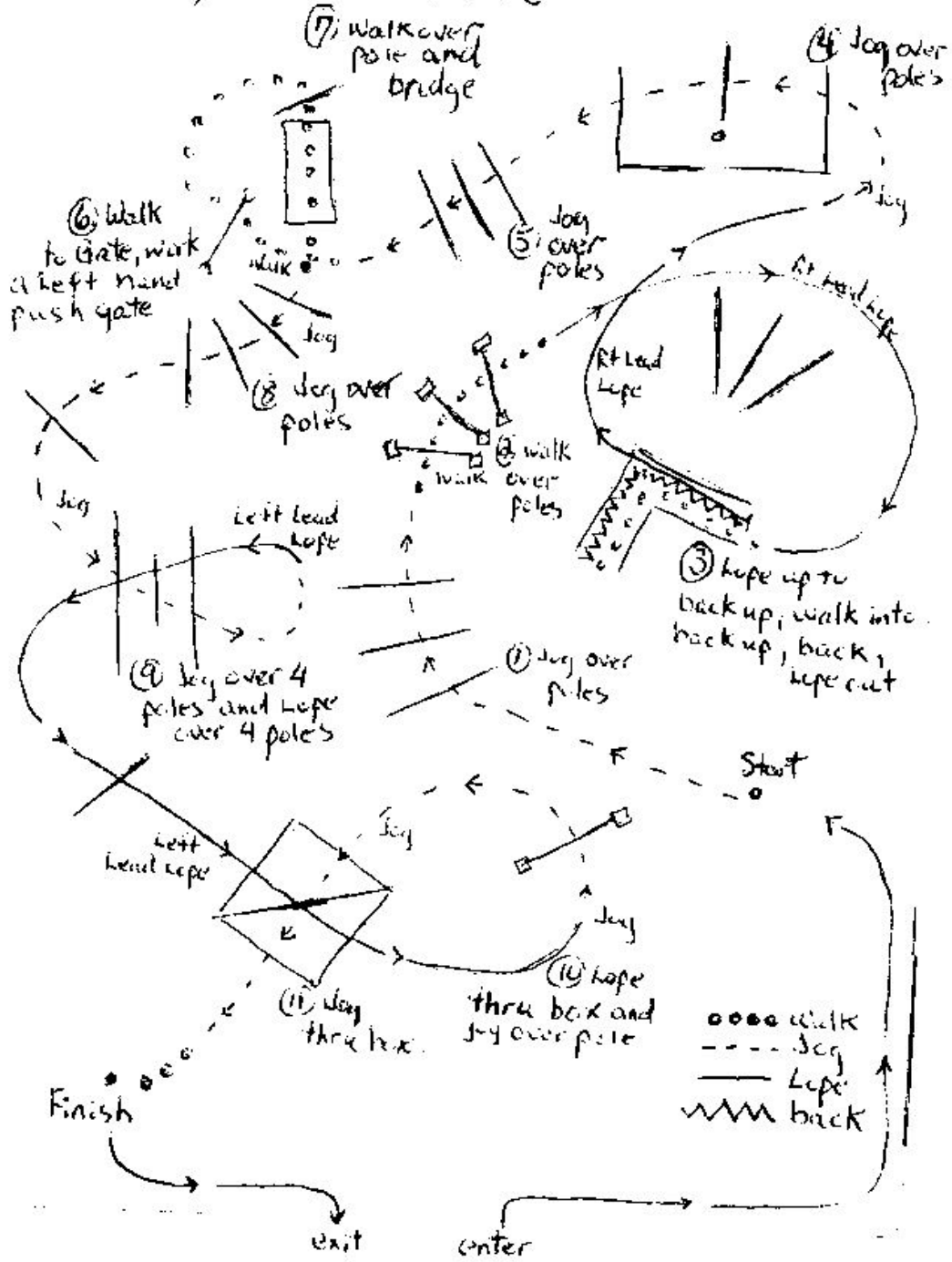



FRIDAY JULY 2

# Sr, Amt, Select Trail

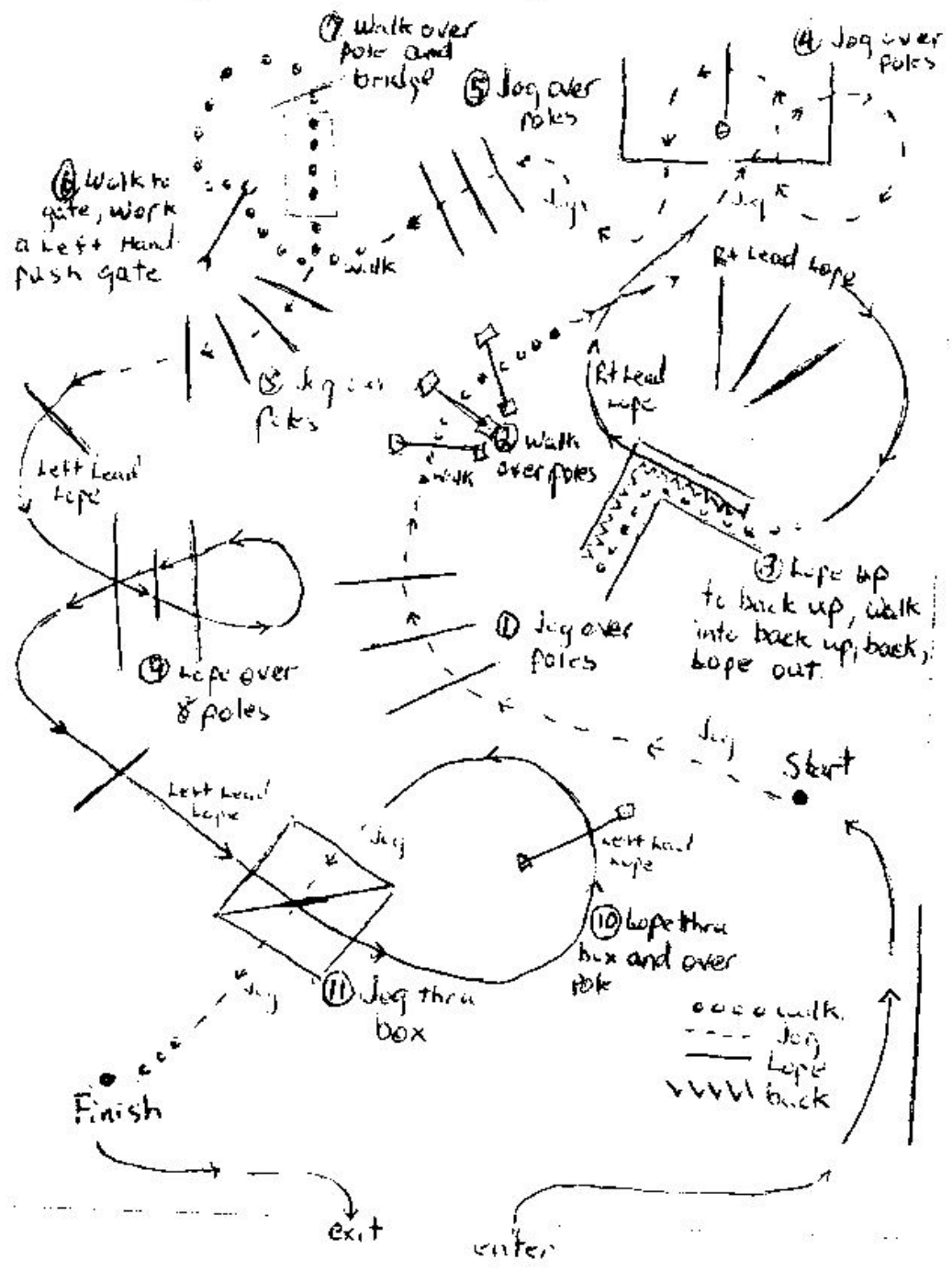

# SUMMERAMA 2010, 25<sup>th</sup> Anniversary

Friday, July 2, 2010

*Judges:* CLAY MACLEOD, Ca  
DEBBIE CUVELIER,

## HORSEMANSHIP

NOV. AMATEUR  
NOV. YOUTH  
13 & UNDER

FINISH

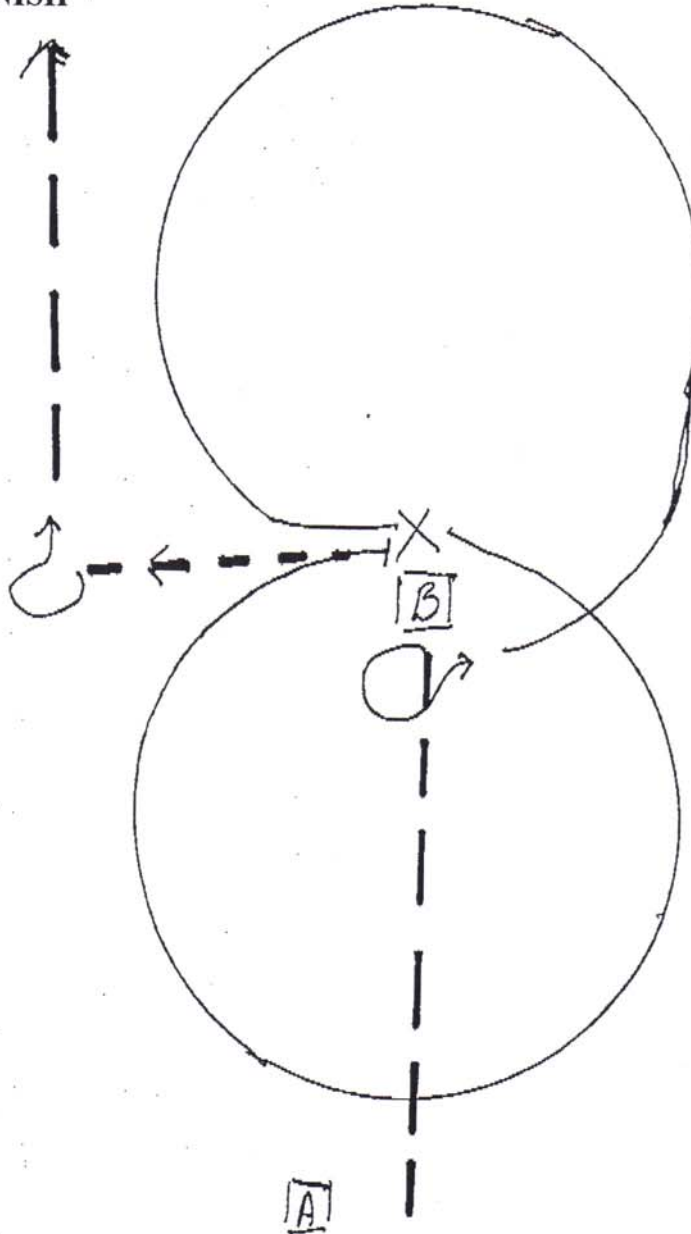

1. Begin at Marker A, extend the trot to Marker B
2. Stop and do 270 left turn
3. Lope a circle left lead
4. Simple or flying lead change
5. Lope a circle right lead
6. Stop and back six steps
7. 270 turn right and extend the trot to finish

START







# SUMMERAMA 2010, 25<sup>th</sup> Anniversary

Saturday, July 3, 2010

*Judges:* JOHN TUCKEY, Ky  
MARTY JO HAYS, Oh

**HORSEMANSHIP:** 13 & Under Youth  
All Novices

- At cone A, 360 degree turn to the left.
- Lope, left lead, to cone B, and stop.
- 180 degree turn to the right. Lope a circle, right lead, as shown, to cone C. Stop.
- 180 degrees turn to the left.
- Extended jog to cone D.
- Stop, and back to complete pattern.

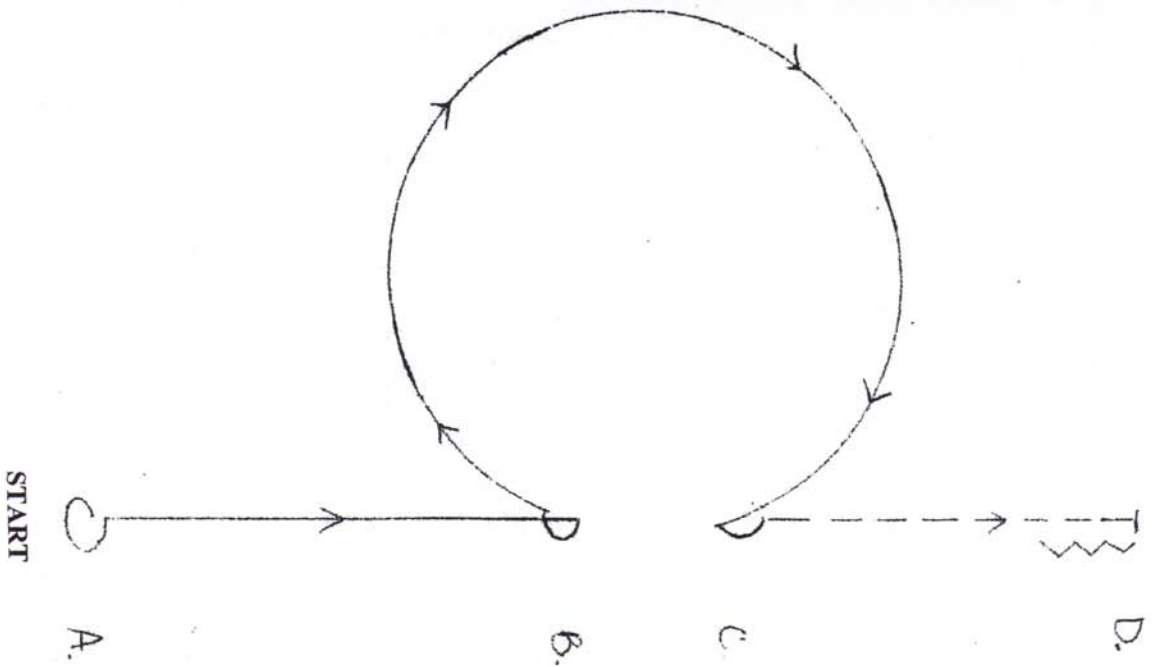



**SUMMERAMA 2010, 25<sup>th</sup> Anniversary**  
**Showmanship NOVICE YOUTH &**  
**Sunday, July 4, 2010 NOVICE AMATEUR**

www.HorseShowPatterns.com

www.HorseShowPatterns.com

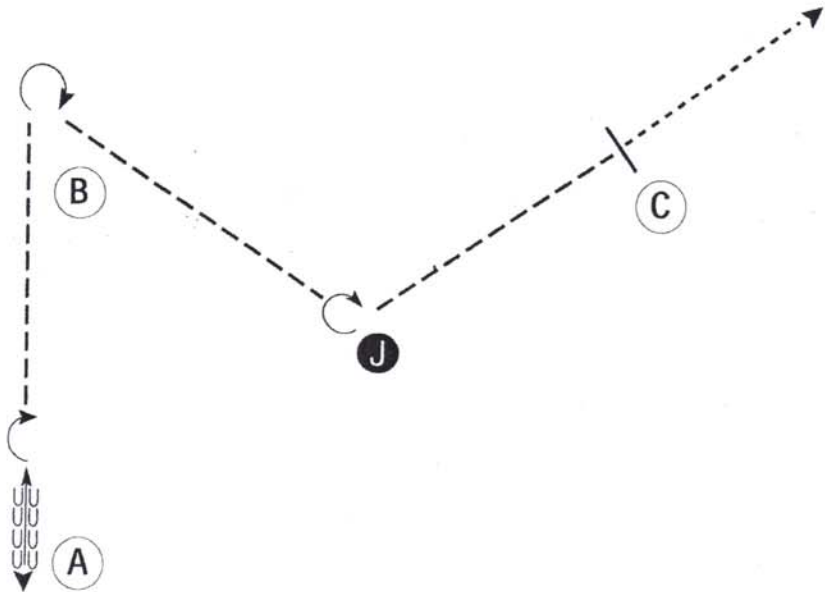

- Be ready at A facing away from B.
1. Back one horse length from A.
  2. Turn 180 degrees and trot past B.
  3. Stop past B, turn 135 degrees and trot to judge.
  4. Stop and set up for inspection.
  5. When dismissed, do a 3/4 turn and trot to C.
  6. Stop at C. When dismissed, walk straight away from C to exit.

Walk -----  
 Trot - - - - -  
 Back ← 〰〰〰〰〰  
 Marker (B)  
 Judge (J)

[S/2-24]

**Pattern Provided by:**

**Judges: CLAY MACLEOD, Ca**  
**DEBBIE CUVELIER,**

**SUMMERAMA 2010, 25<sup>th</sup> Anniversary**  
Sunday, July 4, 2010

*Judges:* CLAY MACLEOD, Ca  
DEBBIE CUVELIER, Wi

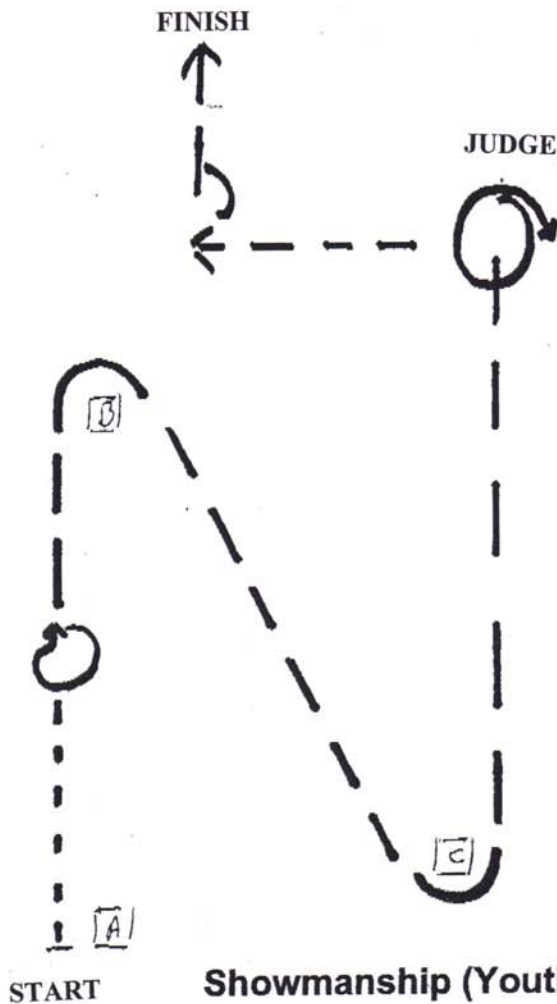

**Showmanship (Youth, Amateur, Select)**

1. Begin at Marker A, Walk halfway to B
2. Stop, do 360 turn right
3. Trot around B
4. Continue trotting around C, straight to the judge
5. Stop and set up for inspection
6. When dismissed, perform a 1 ¼ turn right
7. Back six steps
8. Perform a 90 degree pull turn left and trot to finish

SUMMERAMA 2010, 25<sup>th</sup> Anniversary

Showmanship (Small Fry)

Sunday, July 4, 2010

www.HorseShowPatterns.com

www.HorseShowPatterns.com

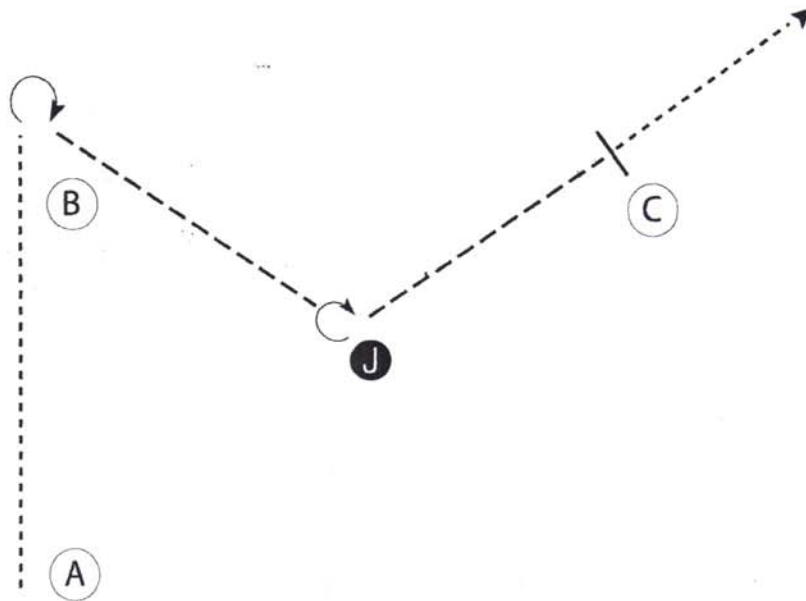

Be ready at A.

1. Walk to and past B.
2. Stop past B, turn 135 degrees and trot to judge.
3. Stop and set up for inspection.
4. When dismissed, do a 3/4 turn and trot to C.
5. Stop at C. When dismissed, walk straight away from C to exit.

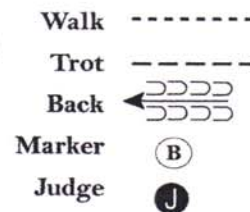

[S/WT-24]

Pattern Provided by:

Judges: DEBBIE CUVELIER,  
CLAY MACLEOD, Ca

**SUMMERAMA 2010, 25<sup>th</sup> Anniversary**  
Sunday, July 4, 2010

*Judges:* CLAY MACLEOD, Ca  
DEBBIE CUVELIER, Wi





EQUITATION

**NOV. AMATEUR, NOV. YOUTH, 13 & Under**

**INSTRUCTIONS:**

1. SITTING TROT TO SECOND MARKER
2. AT SECOND MARKER, CANTER SEMI-CIRCLE TO THE RIGHT (RIGHT LEAD)
3. CLOSE CIRCLE AT POSTING TROT.
4. AT THIRD MARKER, STOP & BACK
5. PICK UP LEFT LEAD AND CANTER PAST FOURTH MARKER.

-----

	MARKER
	TROT
	CANTER
	BACK

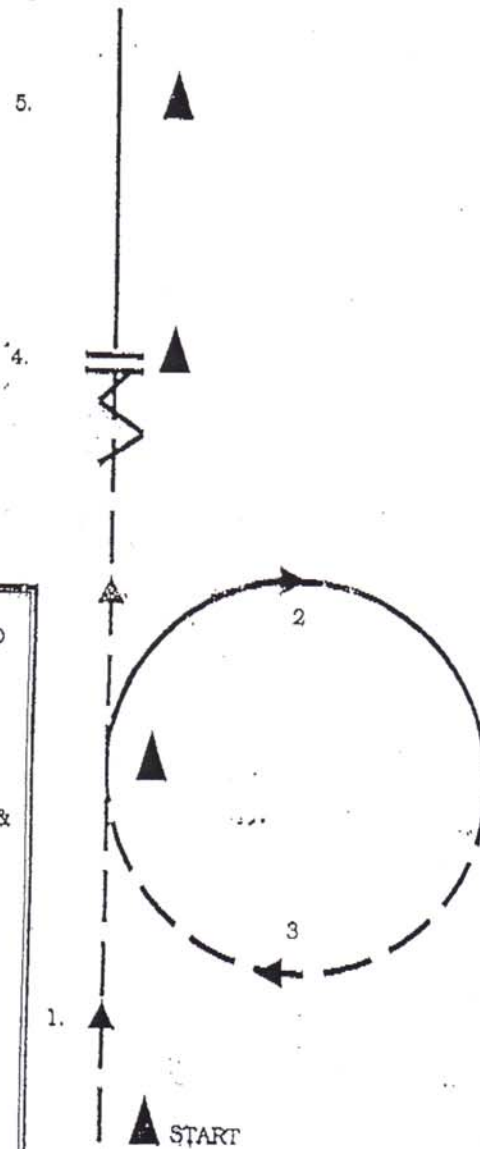

# SUMMERAMA 2010, 25<sup>th</sup> Anniversary

**Hunt Seat Equitation** | AMATEUR, SELECT  
14-18  
Sunday, July 4, 2010

www.HorseShowPatterns.com

www.HorseShowPatterns.com

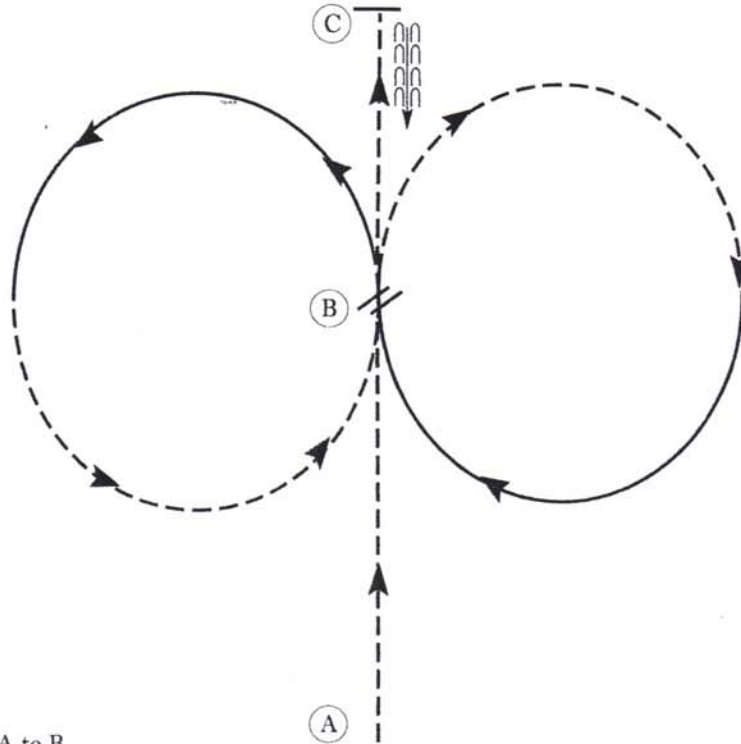

1. Sitting trot A to B
2. At B posting trot on the left diagonal in a half circle.
3. Canter on the right lead back to B.
4. Change leads at B and canter on the left lead in a half circle.
5. Posting trot on the right diagonal back to B.
6. Sitting trot to C.
7. Stop at C and back approximately one horse length.

Exit at a sitting trot.

Walk	-----
Trot	- - - - -
Extended Trot	-----
Canter	-----
Leg Yield	
Lead Change	
Back	←←←
Marker	(B)
Sidepass	←→
Hand Gallop	-----

[HSE/3-21]

**Pattern Provided by:**

**Judges: DEBBIE CUVELIER,  
CLAY MACLEOD, Ca**